



VIEW 1300

OPERATING AND MOUNTING INSTRUCTIONS

Version: 0.1 Draft

Contents

1	EOX® VIEW 1300	3			
1.1	Safety notes	3	3.	Operation	12
1.2	Product concept	3	3.1	Initial wake-up	12
2.	User interface	4	3.2	Controlling ride menu	13
2.1	Segmented display area	5	3.3	Trip reset	13
2.1.1	Battery level	5	3.4	Power off	13
2.1.2	Assist mode	5	3.5	Settings	13
2.1.3	Light status	6	3.6	Disconnect E-System	13
2.1.4	E-System and smartphone connection indicator	6	3.7	Connect E-System	14
2.1.5	Backlight indicator	7	3.8	E-System diagnostic information	15
2.1.6	Speed	7	3.9	Connect HR sensor	16
2.1.7	Clock	8	3.10	Disconnect HR sensor	16
2.2	Multifunctional display area	9	3.11	Device totals	17
2.2.1	Estimated range and assist mode	9	3.12	Service alert	17
2.2.2	Human vs. motor power	9	4	EOX® APP	19
2.2.3	Heart rate and benefit indicator	9	5	KOMOOT APP	24
2.2.4	Gear level and shifting advice	10	6	EOX® ASSEMBLY	28
2.2.5	Komoot turn-by-turn instructions	10	6.1	Over Clamp Butler	29
2.2.6	All functions of multifunctional area	11	7	Technical information	30
			8	Product care	30
			8.1	Transport and storage	30
			9	Disposal	31

1.1 Safety notes

Read the safety notes and the manual before putting the EOX® VIEW 1300 into operation! Improper use can cause damage of the component and/or injuries.

Save the safety notes and the manual for your future reference!

- Make sure not to be distracted by the EOX® VIEW 1300 during the ride! Do not be distracted by the display.
- Make sure not to loose control of the E-Bike when interacting with EOX® VIEW 1300.
- Do not use the EOX® VIEW 1300 as a handle to lift up your E-Bike! This can lead to irreparable damage of the component.

1.2 Product concept

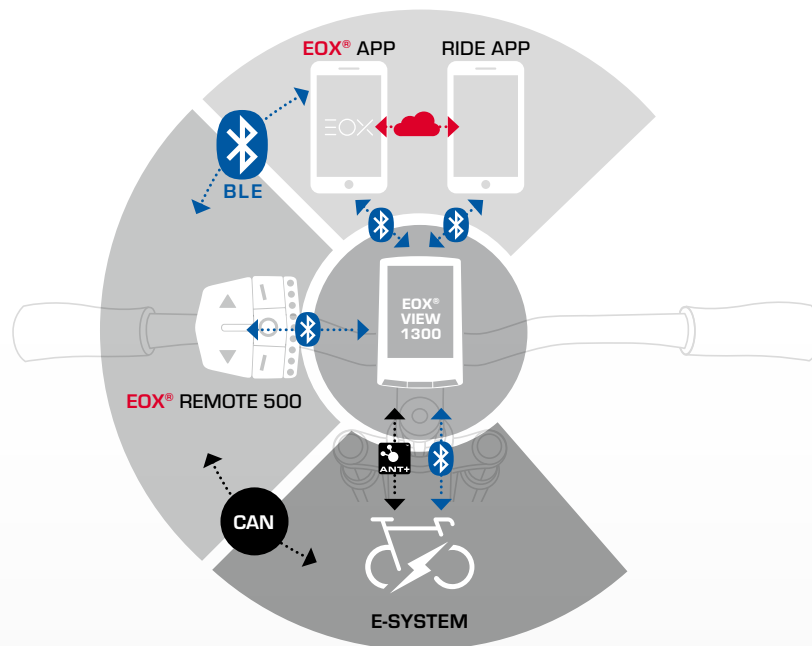

EOX® VIEW 1300 is wirelessly connected to the E-System by Bluetooth Smart or ANT+. Communication can be enabled by EOX® REMOTE 500 or any other BLE/ANT+ component. EOX® VIEW 1300 communicates by BLE with EOX® App.

Wireless SIGMA E-Bike Computer offer the greatest possible flexibility and a wealth of additional features and functions. They allow cable free hence clean cockpit solutions for E-Bikes using our partner's E-Systems.



More details about compatible E-Systems can be found here: [\[LINK\]](#)

2. User interface



The VIEW 1300 integrates 3 buttons (A / B / C) to control its user interface (see chapter 3).

2.1 Segmented display area

2.1.1 Battery level

- Battery level of E-System is shown in segment area
- Logic of battery indicator depends on E-System connected
- Detailed information can be found here: [LINK](#)
- SIGMA default logic of battery indicator is described below:

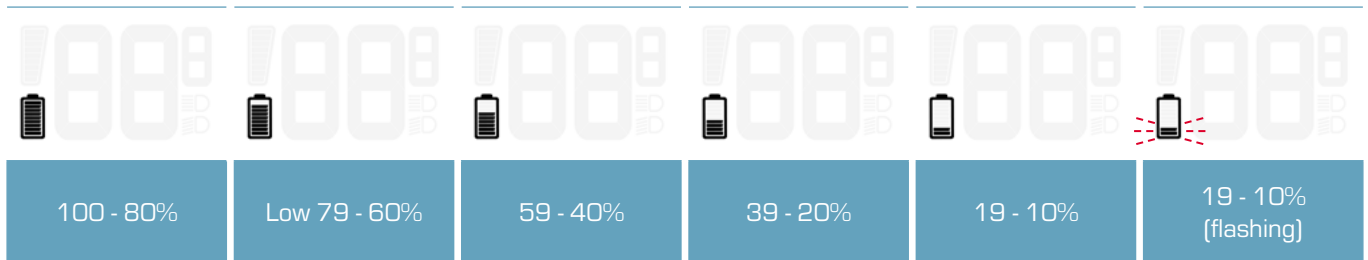

2.1.2 Assist mode

- Currently selected Assist Mode is shown permanently in segment area
- Assist mode indicator is filled from bottom to top with Assist Mode increasing
- SIGMA default logic of Assist Mode indicator is described below:



- Changing Assist Mode can further be indicated by a pop-up message (2s)
- This message includes the Assist Mode name and can be en-/disabled in EOX® VIEW 1300 settings or by EOX® App
- SIGMA default logic of Assist Mode pop-up message is described below:

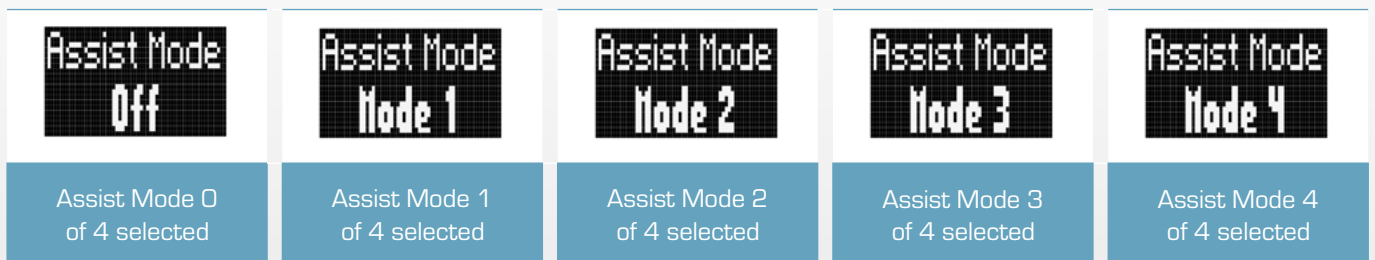

- Names and number of Assist Modes and, thus, behaviour of Assist Mode indicator depend on E-System connected
- Detailed information can be found here: [LINK](#)

2.1.3 Light status

- Light status level of E-System is shown in segment area
- Light status can either be off, low beam, or high beam
- Whether high beam function is available or not depends on E-System setup

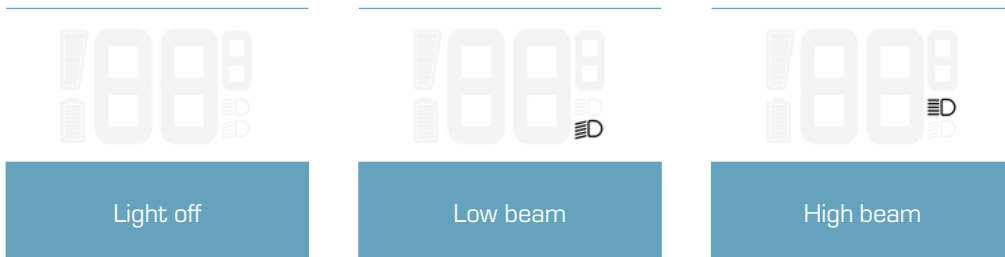

2.1.4 E-System and smartphone connection indicator

- Connection status of E-System and Smartphone are shown in segment area
- Two icons indicate whether connection is established or not

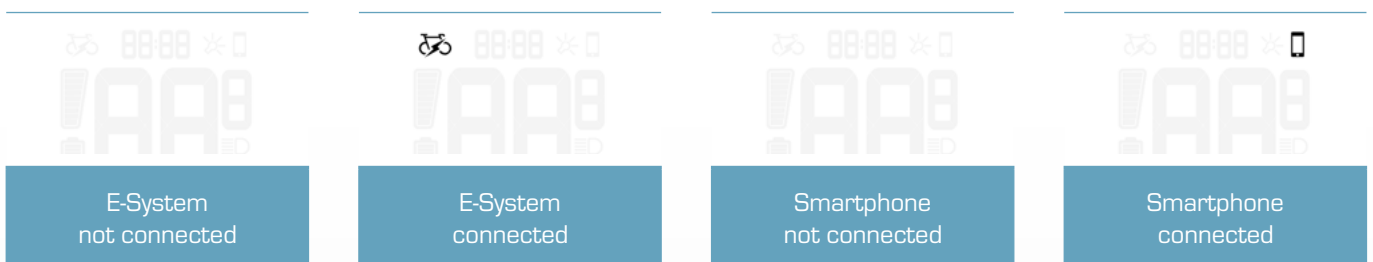

- Connection and disconnection of E-System or Smartphone are further indicated by a pop-up message (2s)

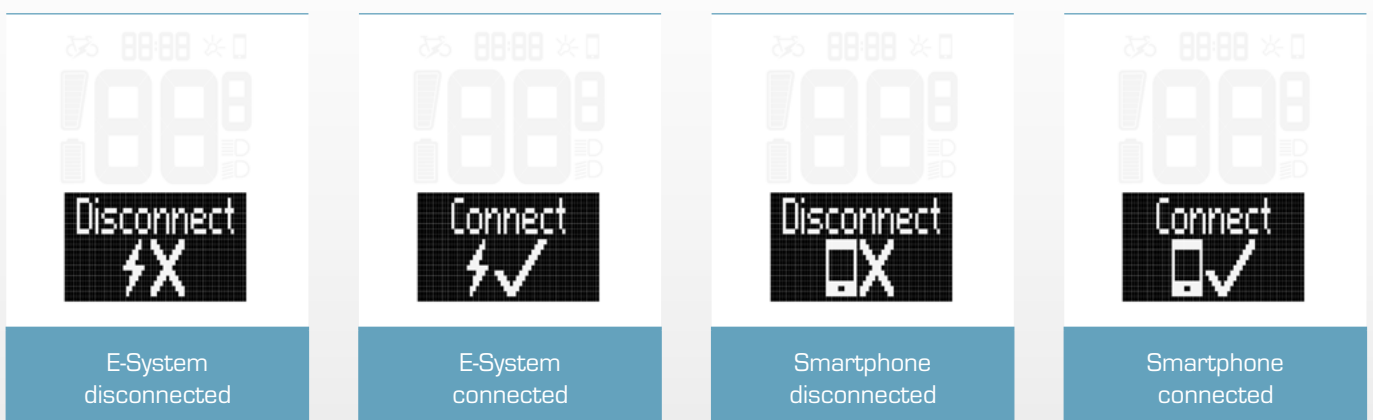

2.1.5 Backlight indicator

- Backlight mode of EOX® VIEW 1300 is indicated in segment area.

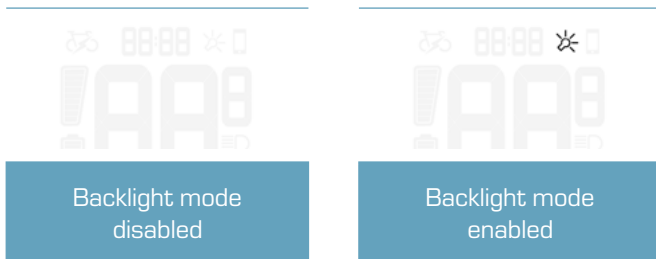

- With integrated ambient light sensor EOX® VIEW 1300 automatically enables backlight mode in dark conditions and disables backlight mode in bright conditions.
- Once backlight mode is enabled backlight is turned on for 2s with each button press.
- If backlight is off, first button press only turns backlight on and does not trigger any other action.

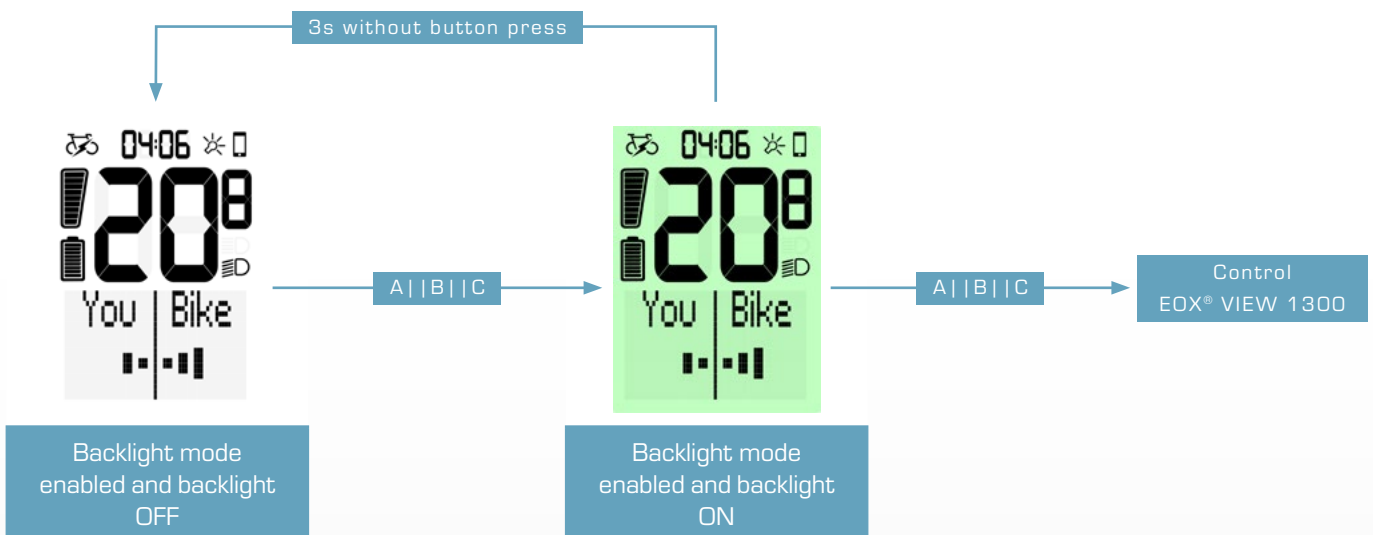

2.1.6 Speed

- Current speed of E-System is permanently shown in EOX® VIEW 1300 segment area
- Speed unit (kmh or mph) depends on device settings (see chapter 3.5)

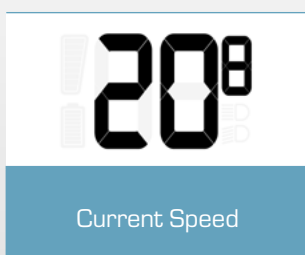

2.1.7 Clock

- Clock is permanently shown in EOX® VIEW 1300 segment area.
- Clock can be set manually (see chapter 3.5) and will be set automatically each time EOX® App is connected.
- Clock format (12h or 24h) depends on device settings (see chapter 3.5)



Current Clock



2.2 Multifunctional display area

2.2.1 Estimated range and assist mode

- Estimated range and name of current assist mode can be shown combined in EOX® VIEW 1300 multifunctional area.

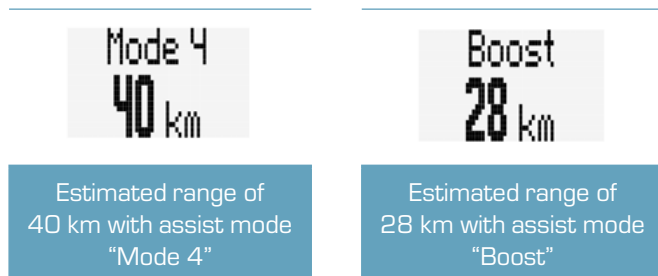

2.2.2 Human vs. motor power

- Multifunctional area of EOX® VIEW 1300 can show a visual comparison between human and motor power.
- The harder you pedal the more the display deflects to the left.
- The more power is added by the motor the more the display deflects to the right.



2.2.3 Heart rate and benefit indicator

- The multifunctional area of the EOX® VIEW 1300 can show the current heart rate if an external heart rate sensor is connected (see chapter 3.9).
- The benefit indicator provides feedback for the training effect of your activity.

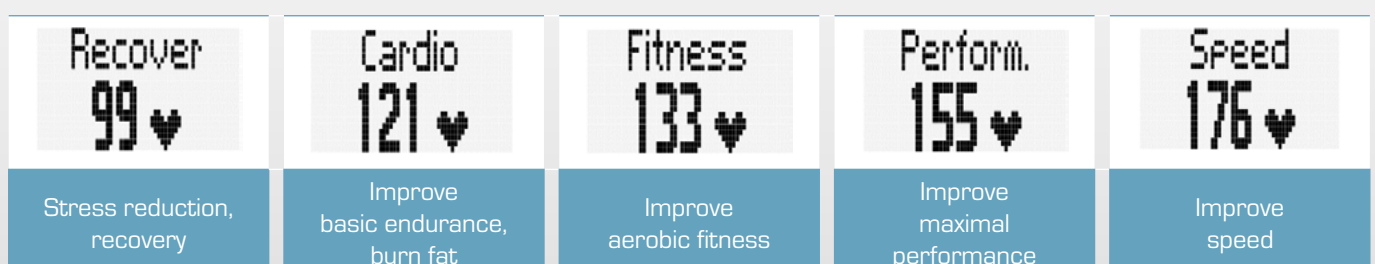

2.2.4 Gear level and shifting advice

- Current rear gear can be shown on EOX® VIEW 1300 multifunctional area.
- Visual representation indicates whether lowest (A), highest (B), or any intermediate gear (C, D, E) is selected.
- If E-System advises to shift (up or down) an indicator is shown right to the visual (D, E).

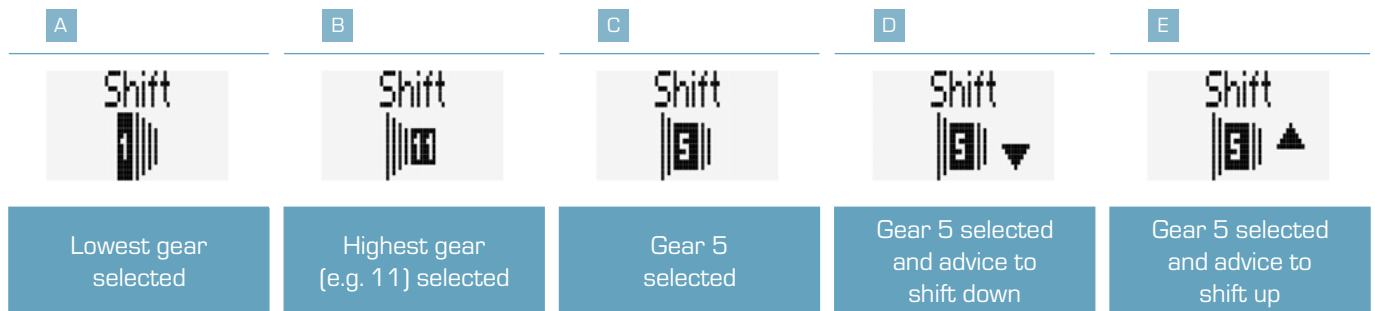

2.2.5 Komoot turn-by-turn instructions

- EOX® VIEW 1300 can show turn-by-turn instructions from Komoot app on multifunctional area if Komoot app is connected (see chapter 5).



- Additionally, a pop-up message is shown if distance towards next turning situation falls below 75 m.
- This pop-up message will only be shown if Komoot function is not selected in multifunctional area.

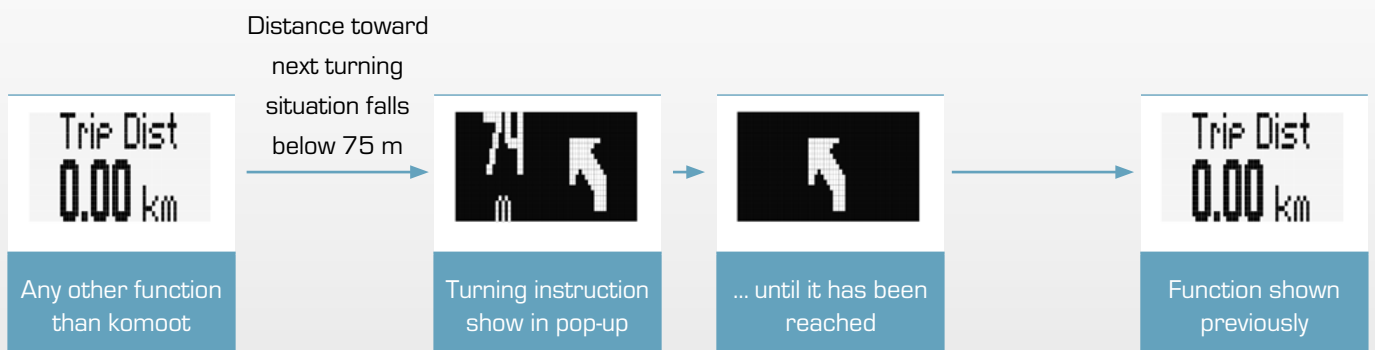

2.2.6 All functions of multifunctional area

 <p>Trip Dist 0.00 km</p>	 <p>Ride Time 0:00 min</p>	 <p>Ava Speed 0.00 kmh</p>	 <p>Max Speed 0.00 kmh</p>
Distance since last trip reset	Ride time since the last trip reset	Average speed since the last trip reset	Maximum speed since the last trip reset
 <p>Temperature 0.0 °C</p>	 <p>Cadence 0 rpm</p>	 <p>Power 0 watt</p>	 <p>Mode 1 100 km</p>
Environmental temperature	Cadence	Human power	Estimated range and assist mode (see chapter 2.2.1)
 <p>Date 05.12.20</p>	 <p>You Bike</p>	 <p>Recover 100 ♥</p>	 <p>Calories 0 Kcal</p>
Date	Human vs. motor power (see chapter 2.2.2)	Heart rate and benefit indicator (if external sensor connected, see chapter 2.2.3)	Calories (if external sensor connected)
 <p>1.2 km</p>	 <p>Shift</p>		
Komoot turn-by-turn instructions (see chapter 2.2.5)	Gear and shifting advice (see chapter 2.2.4)		

- Availability of functions depends on E-System connected
- Detailed information can be found here: [\[LINK\]](#)

3 Operation

3.1 Initial wake-up

- Long-press **B** button (> 5 s) to wake-up EOX® VIEW 1300 from shipping mode.
- You'll be guided through initial settings of EOX® VIEW 1300 (**A**).
- If you purchased EOX® VIEW 1300 being part of E-System, both can already be paired. If so, start with (**B**).

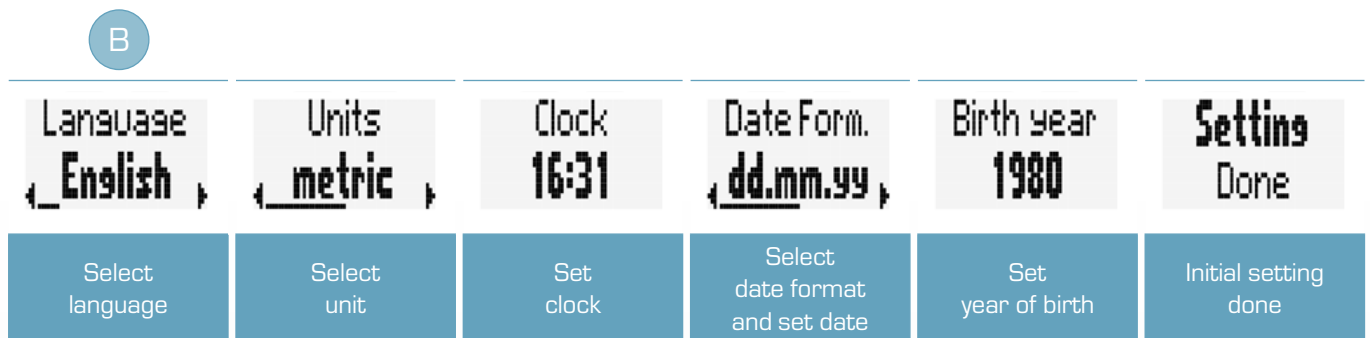

! Ensure E-System is turned on and Bluetooth interface is advertising while EOX® VIEW 1300 is scanning for compatible E-Systems.



- SHIMANO STePS system can be found by Bluetooth for 30s after power on or pressing a button of STePS system.
- To ensure Bike Computer can find STePS system it is recommended to press button of STePS system (e.g. button of EOX® Ribbon Butler) while Bike Computer searches for compatible E-Systems.

3.2 Controlling ride menu

- To change functions shown in multifunctional area of EOX® VIEW 1300 press **A** or **C** button in ride menu.

3.3 Trip reset

- To reset trip data of EOX® VIEW 1300 long-press **C** button (>2 s).

3.4 Power off







- To power off EOX® VIEW 1300 long-press **A** button (>5 s).

3.5 Settings

- Long-press **B** button (>2 s) to enter menu.
- Select item Settings and short-press **B** button.
- Following settings can be done:
 1. Language: English, German, French, Italian, Spanish, Dutch, Polish, Czech
 2. Units: metric (°C, kmh), imperial (°F, mph)
 3. Clock
 4. Date
 5. Contrast: 1, 2, 3
 6. Year of birth
 7. Assist pop-up: on, off
 8. Maximum heart rate: auto, manual

3.6 Disconnect E-System

- Note: disconnecting the E-System is only necessary if you want to switch EOX® VIEW 1300 to another bike.

						
Long-press B button (>2 s) and wait menu to open	Select Connection and press B button	Select E-Bike and press B button	Select Disconnect E-Bike? and press B button	Select Yes and press B button	EOX® VIEW 1300 and E-System are now disconnected	

3.7 Connect E-System

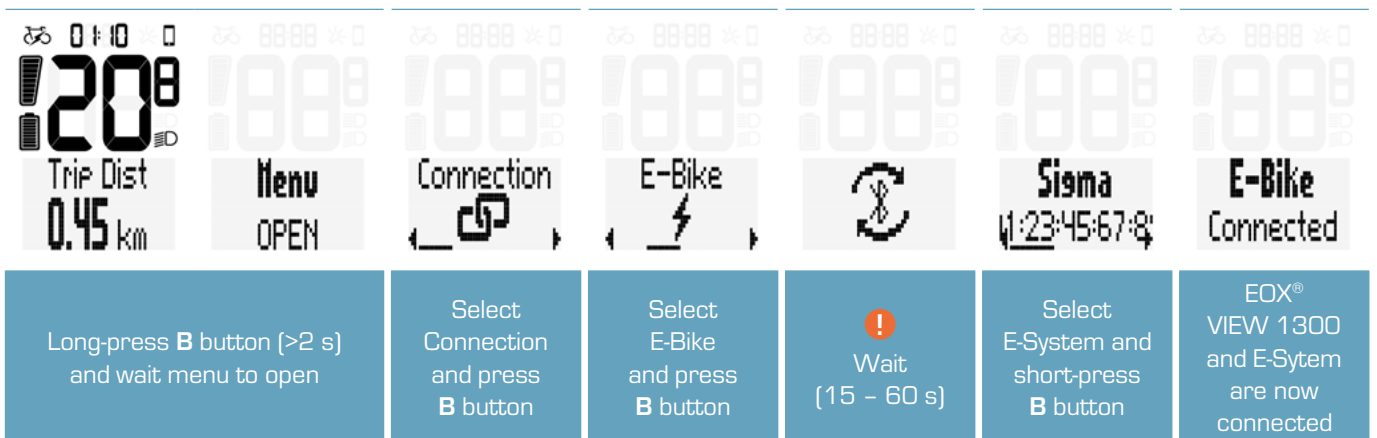

- ! Ensure E-System is turned on and Bluetooth interface is advertising while EOX® VIEW 1300 is scanning for compatible E-Systems.







SHIMANO STePS

- SHIMANO STePS system can be found by Bluetooth for 30s after power on pressing a button of STePS system.
- To ensure Bike Computer can find STePS system it is recommended to press button of STePS system [e.g. button of EOX® Ribbon Butler] while Bike Computer searches for compatible E-Systems.

- Once EOX® VIEW 1300 and an E-Bike are connected by menu the connection will be established automatically the next times within 10s.
- If the automatic connection takes longer:
 - > Check that both devices are turned on.
 - > Check that E-Bike Bluetooth interface is advertising.
 - > Pressing any button of EOX® VIEW 1300 will enable fast searching mode.

3.8 E-System diagnostic information

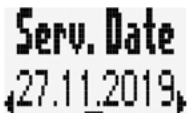
- EOX® VIEW 1300 shows diagnostic information of paired E-System
- Long-press **B** button (>2 s) to enter menu.
- Select item Connection and short-press **B** button.
- Select item E-Bike and short-press **B** button.
- The following diagnostic information can be shown:

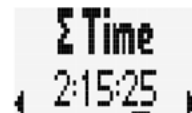
			
<p>Name of paired E-System</p>	<p>Serial number of paired E-System</p>	<p>Wireless protocol version of E-System (if E-System connected)</p>	<p>Total distance value the next system service is due (if E-System connected)</p>
			
<p>Date the next system service is due (if E-System connected)</p>	<p>Total distance (Odometer) of E-System (if E-System connected)</p>	<p>Total ride time of E-System (if E-System connected)</p>	

- Availability of diagnostic information depends on E-System connected.
- Detailed information can be found here: [\[LINK\]](#)



3.9 Connect HR sensor

Long-press B button (>2 s) and wait menu to open	Select Connection and press B button	Select Heartrate and press B button	Wait (15 - 60 s)	Select HR sensor and press B button	EOX® VIEW 1300 and HR sensor are now connected	







- You can also use EOX® App to connect a HR sensor with EOX® VIEW 1300 (see chapter 4)

3.10 Disconnect HR sensor

Long-press B button (>2 s) and wait menu to open	Select Connection and press B button	Select Heartrate and press B button	Select Disconnect Heartrate? and press B button	Select Yes and press B button	EOX® VIEW 1300 and HR sensor are now disconnected	

3.11 Device totals

- EOX® VIEW 1300 records its own total distance and ride time independent from E-System.
- Long-press **B** button (>2 s) to enter menu.
- Select item Totals and short-press **B** button.
- It is possible to manipulate the device total values:

			
Short-press B button to change totals	Set ten thousands digit and short-press B button	Set thousands digit and short-press B button	Set hundreds digit and short-press B button
			
Set tens digit and short-press B button	Set ones digit and short-press B button	Total value (i.e. distance) set to new value	

3.12 Service alert

- EOX® VIEW 1300 shows a pop-up message if service of connected E-System is due.
- The service alert can be defined based on total ride distance and/or date.
- This pop-up message will be shown once (when it happens) and each time EOX® VIEW 1300 is powered on again until service is done.

Service alert pop-up message





EOX[®]
APP

4. SIGMA EOX[®] App

SIGMA EOX[®] App is available in the Google Play Store and Apple App Store.



Compatibility:

The app can be installed on Android version 5.0 and higher as well as on iOS version 11.0 and higher.

Languages: German, English, French, Italian, Dutch, Polish, Spanish, Czech

4.1 Connect EOX[®] VIEW 1300 with EOX[®] App

- Make sure EOX[®] VIEW 1300 is turned on and your smartphone is around.
- Enable Bluetooth  on your smartphone and start EOX[®] App.
- Follow the App instructions to connect EOX[®] products.
- Now a data transfer is guaranteed.



Menu “Trip recording”

Tap on  to record a trip.

The following values are shown:

- Location on the map
- Distance
- Ride time
- Average speed
- Maximum speed
- Average heart rate (only if heart rate sensor is connected)
- Maximum heart rate (only if heart rate sensor is connected)
- Calories (only if heart rate sensor is connected)
- Average cadence
- Maximum cadence
- Average power
- Maximum power
- Average temperature
- Maximum temperature
- Battery drain
- Assist Modes
- Range

- Starting and stopping Trip recording is indicated at EOX® VIEW 1300 by showing a pop-up message.



Pop-up message indicating that trip recording has been started



Pop-up message indicating that trip recording has been stopped

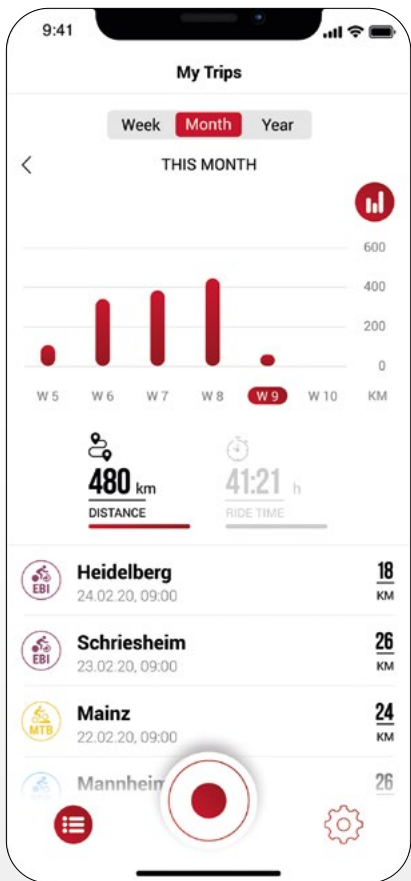

Menu “My trips”

- Summary of all recorded trips
- Weekly, monthly and yearly statistic (distance, ride time)
- Show goal achievement

Menu "Trip"



Following data can be added to the trip individually:





- Trip name
- Trip date and time
- Sport type
- Weather and wind information
- Feeling

The following values are recorded:

- Location on the map
- Ride time
- Average speed
- Maximum speed
- Average heart rate (only if heart rate sensor is connected)
- Maximum heart rate (only if heart rate sensor is connected)
- Calories (only if heart rate sensor is connected)
- Average cadence
- Maximum cadence
- Average power
- Maximum power
- Average temperature
- Maximum temperature
- Battery drain
- Assist Modes



Additional:

- Trip can be shared with third parties in real-time by tapping  (iOS)  (Android).
- By tapping on  (iOS)  (Android), the trip can be individually arranged, edited or deleted.
- By tapping on the map, the trip is shown highlighted in colors. The colors indicate a different view of the trip concerning the following values: speed, heart rate, battery drain and assist modes.

Menu “Settings”

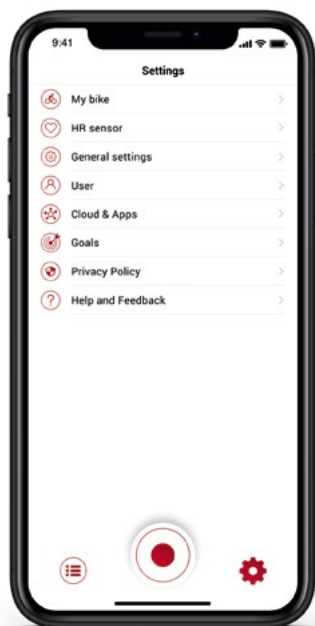

My Bike

- Customized settings, e.g. screens of the EOX® VIEW 1300 can be customized
- Firmware updates for EOX® VIEW 1300
- Total values (distance, ride time)

Connect heart rate sensor

- Via app you can connect a compatible bluetooth heart rate sensor with the EOX® VIEW 1300
- By tapping on  the EOX® App settings will open. Select “Heart rate sensor”.
- Follow the app instructions to connect a heart rate sensor with the EOX® REMOTE 500 or EOX® VIEW 1300.

General settings

- Set language and scale unit

User

- User settings

Cloud & Apps

- Recorded trips can be synchronized with the SIGMA CLOUD or shared to third party platforms as STRAVA and komoot



Goals

- Set goals to keep yourself motivated

Help & Feedback

- Videos of the EOX® series
- Contact our support

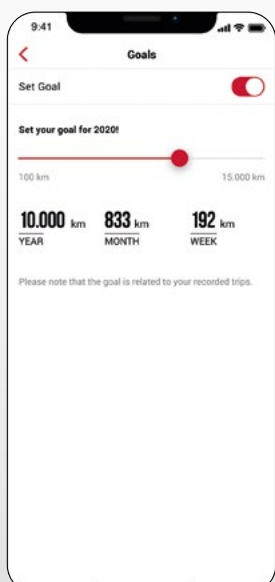
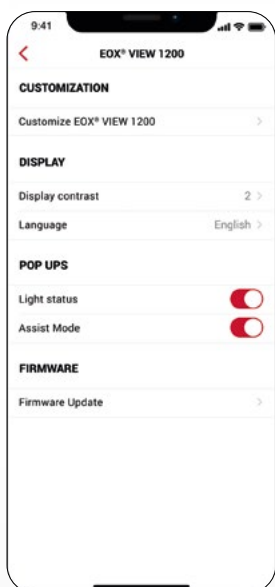



EOX[®]

VIEW 1300

WITH KOMOOT APP

5. Komoot app



5.1 Connect Komoot app

You can connect the komoot app with the EOX® VIEW 1300 to show the turn-by-turn instructions.

Initial Connection

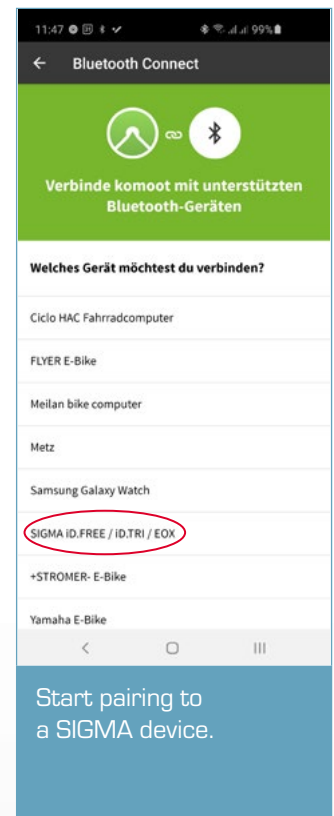
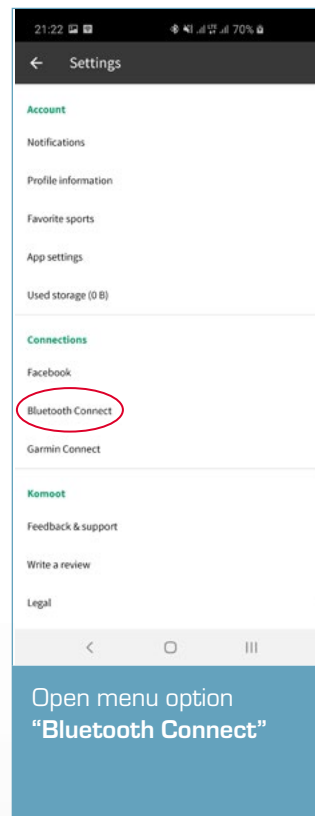
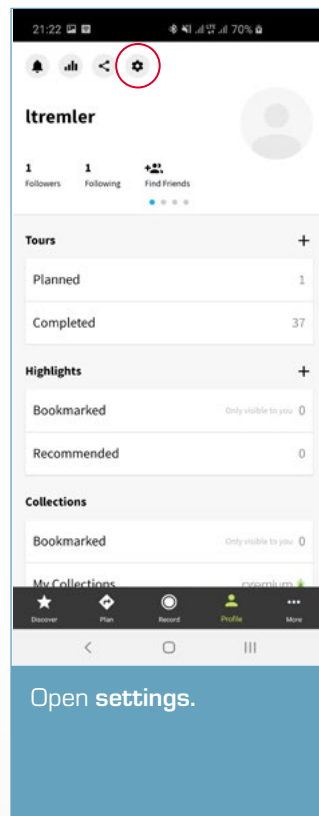

Initial Connection

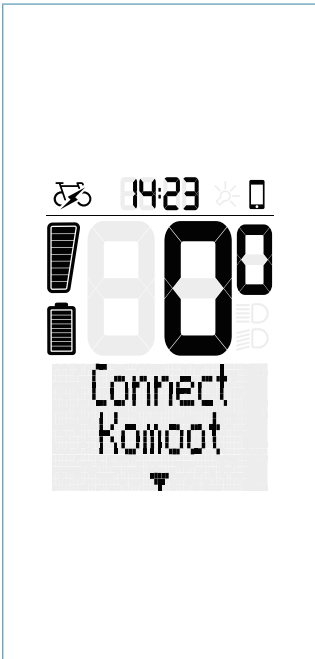

In the Ride menu of EOX® VIEW 1300 navigate to the option „Connect Komoot“ and press B.

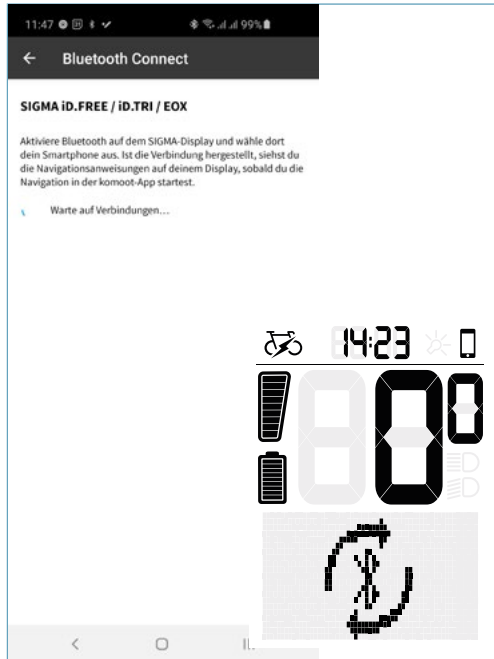

Both Komoot and EOX® VIEW 1300 are now searching for a connection.



Once a connection is established, Komoot and EOX® VIEW 1300 display a message. In case of connection difficulties, start the EOX® app in parallel and connect EOX® VIEW 1300.

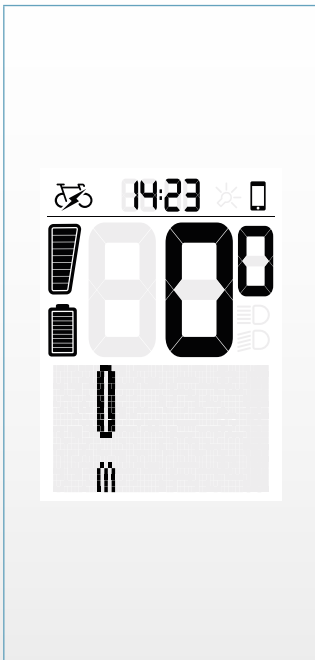

EOX® VIEW 1300 is now ready to receive turn-by-turn instructions from Komoot.

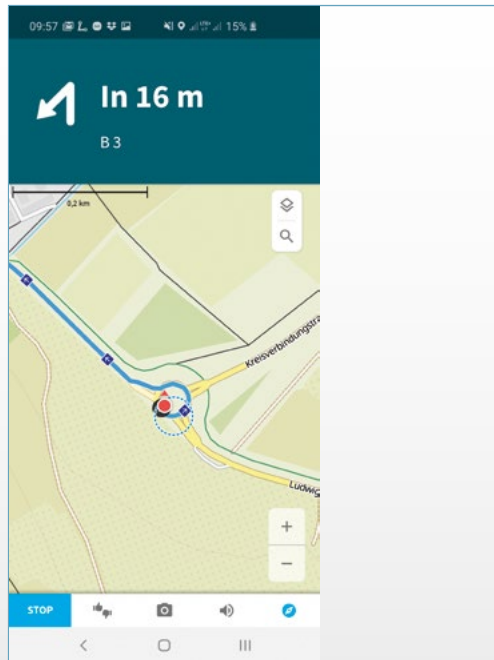

Start a navigation in Komoot. Make sure that your smartphone has GPS reception otherwise navigation instructions cannot be received.

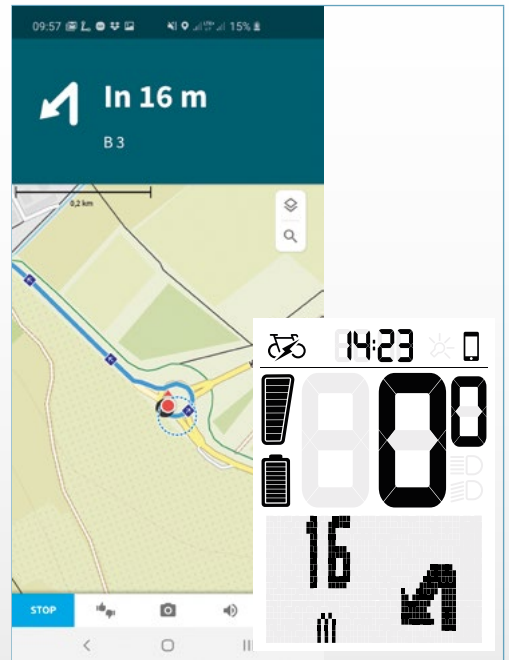

As soon as a connection is established, navigation instructions coming from Komoot are displayed on EOX® VIEW 1300.

Subsequent Connections

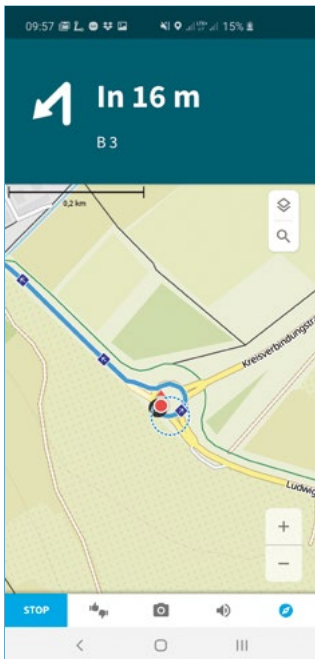

Start a navigation in Komoot. Make sure that your smartphone has GPS reception otherwise navigation instructions cannot be received.

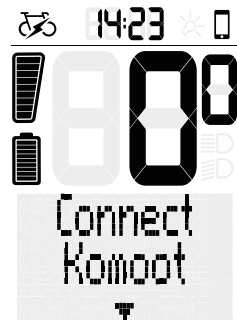

In the Ride menu of EOX® VIEW 1300 navigate to the option **“Connect Komoot”** and press B.

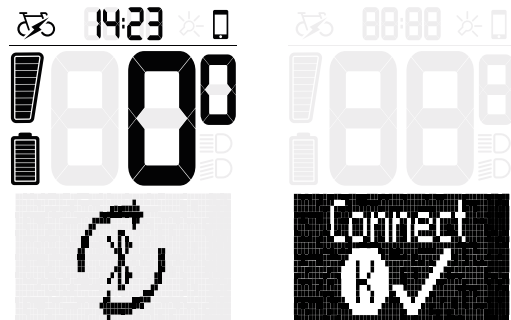

EOX® VIEW 1300 connects to Komoot. In case of connection difficulties, start the EOX® app in parallel and connect EOX® VIEW 1300.

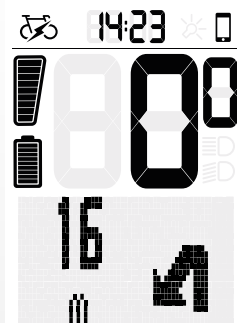
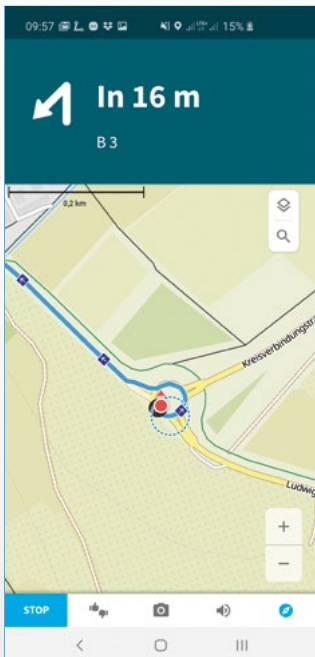

As soon as a connection is established, navigation instructions coming from Komoot are displayed on EOX® VIEW 1300.



EOX[®]
ASSEMBLY

6. Assembly

6.1 Over Clamp Butler

Mounting the EOX® VIEW 1300 on the Over Clamp Butler

- Set the EOX® VIEW 1300 in 11 o'clock position on the Over Clamp Butler
- Turn the EOX® VIEW 1300 to the right until it's straight.
- The EOX® VIEW 1300 is now mounted

Option: With an additional screw (2.5 mm Allen key) it's possible to lock the EOX® VIEW 1300 from the back side of the Over Clamp Butler.

Mounting the Over Clamp Butler to the handlebar

- Wrap thick rubber pad (for 31.8 mm handlebar) or thin rubber pad (for 35 mm handlebar) around the handlebar on the left side of the stem
- Loosen the clamping screw of the Over Clamp Butler (2.5 mm Allen key) and place the Butler on the rubber pad.
- Align the EOX® VIEW 1300
- Tighten the screw (2.5 mm Allen key) with 0.5 Nm

Note: When using the 31.8 mm rubber pad it's possible to adjust the height over the stem by turning the rubber pad



6.2 EOX® Ribbon Butler

Insert EW-EN100 in Ribbon Butler

- Loosen the clamping screw (2.5 mm Allen key)

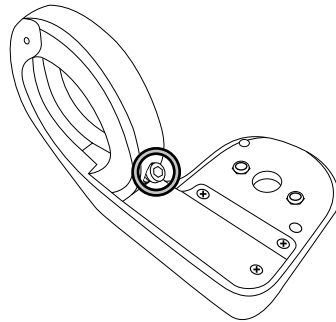

- Open the clamp

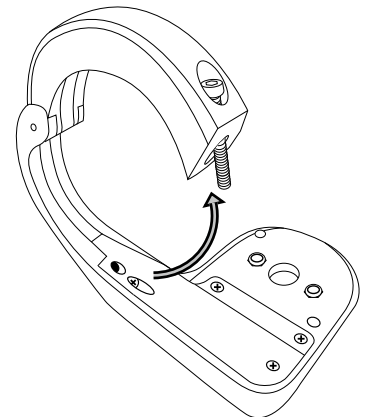

- Loosen the four screws of the back case cover (Phillips-head screw)

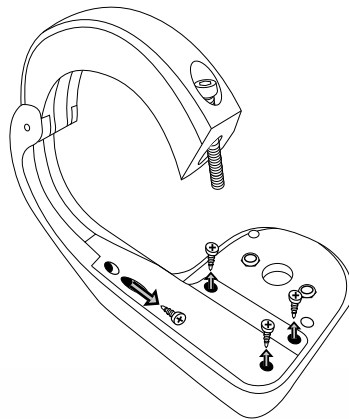

- Open the back case cover

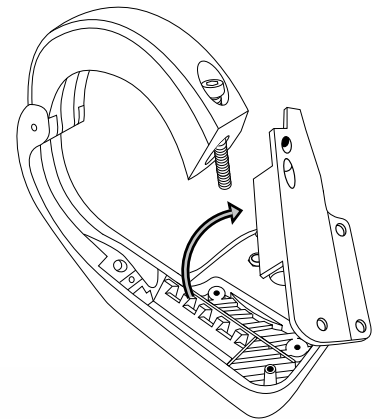

- Connect the cable from motor side to port #1 of EW-EN100.
- Optionally, connect another SHIMANO component (e.g. shifter) EW-EN100 to port #2 of EW-EN100.

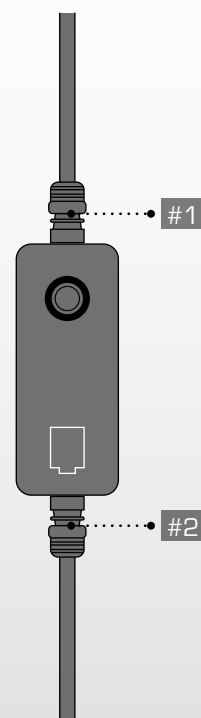

- Insert EW-EN100 in the intended opening.
- Slot #1 must point at the clamp.
- The button must point at the opening on the top side of the Ribbon Butler.
- Carefully, place the cable outlet #1 inside the cable groove.

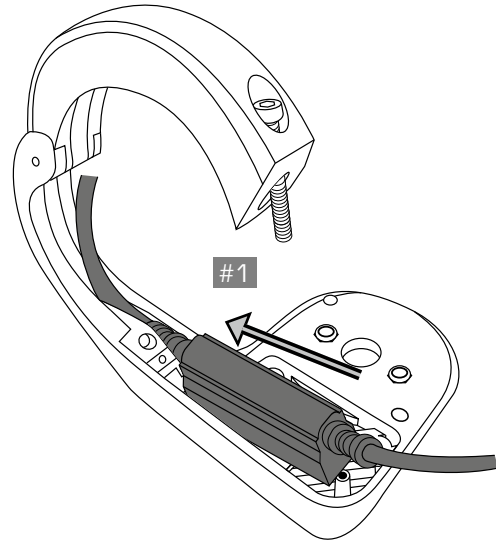

- Press down the EW-EN100 until it fits tightly inside the intended opening.

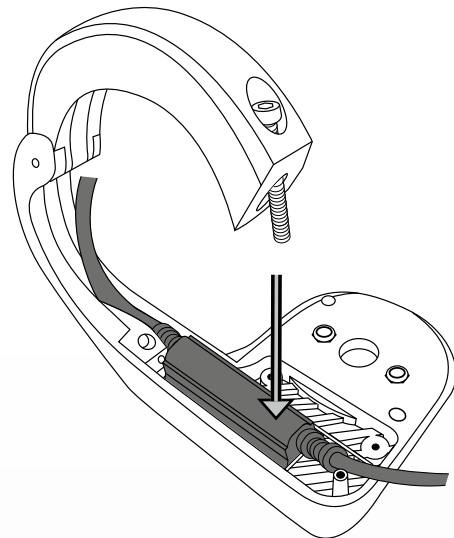

- If a cable is used at port #2 guide it around the pin.
- Guide all cables inside the cable groove.
- Press them down a little to make the tightly fit inside the groove.

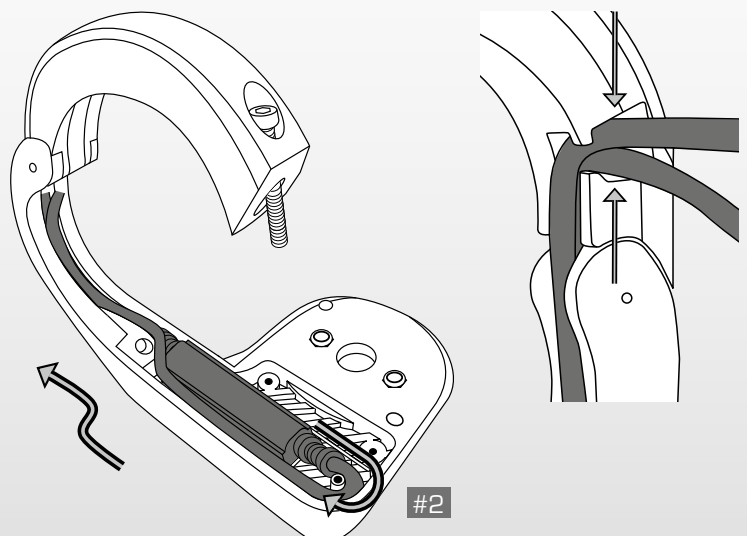

- Slide in the back case cover.

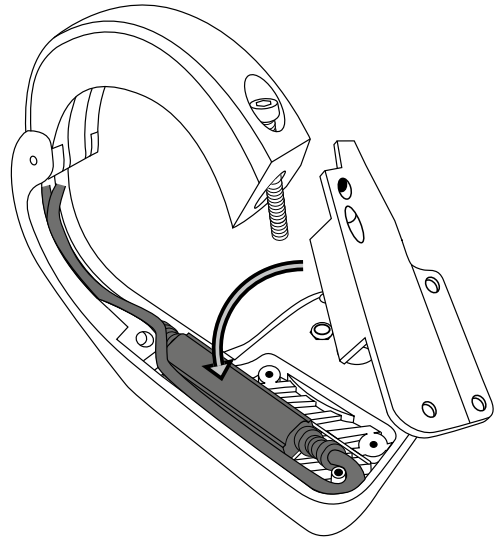

- Press down the cover until it fits tightly inside the intended opening.
- Fix the cover with the four screws (Phillips-head screw).

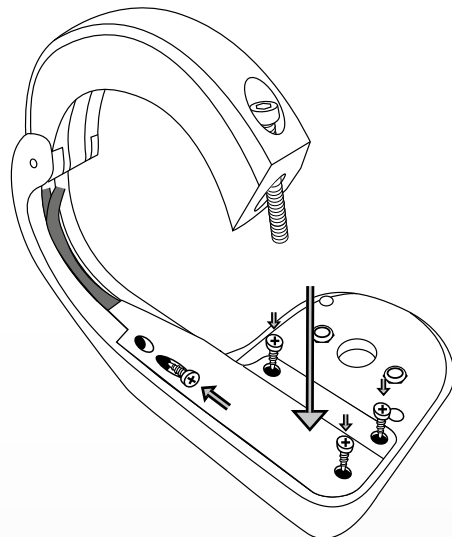

Mounting the EOX® VIEW 1300 on the Ribbon Butler

- Set the EOX® VIEW 1300 in 11 o'clock position on the Ribbon Butler
- Turn the EOX® VIEW 1300 to the right until it's straight.

Option: With an additional screw (2.5 mm Allen key) it's possible to lock the EOX® VIEW 1300 from the back side of the Ribbon Butler.

Mounting the Ribbon Butler to the handlebar

- Wrap a thick rubber pad (for 31.8 mm handlebar) or thin rubber pad (for 35 mm handlebar) around the handlebar on the left side of the stem (out-front mounting) or the right side of the stem (reverse mounting)
- Loosen the clamping screw and place the Ribbon Butler on the rubber pad.
- Take care that the cables run inside the groove and leave the clamp only in the intended opening.
- Align the EOX® VIEW 1300 in riding direction.
- Tighten the clamping screw with:

31.8 mm	35.0 mm
0.90 Nm	0.75 Nm

Note: When using the 31.8 mm rubber pad it's possible to adjust the height over the stem by turning the rubber pad

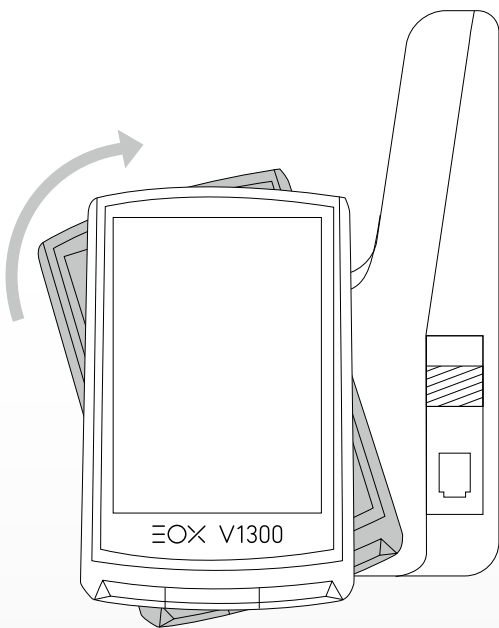

7. Technical information

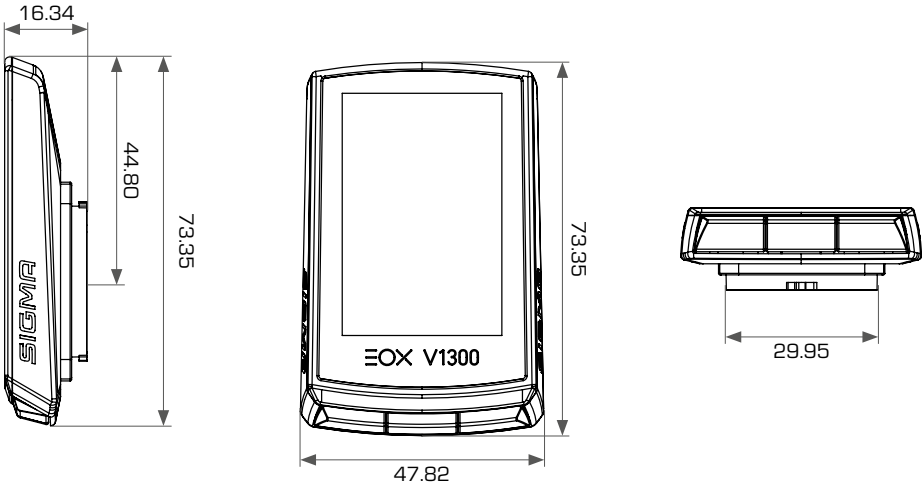
Dimensions	
Weight	43 g
Power supply	CR 2450
IP rating	IPX6K, IPX7
Operating temperature	-10/25/60 °C (min/typ/max)
Storage temperature	-20/25/70 °C (min/typ/max)
Certifications	CE, FCC, ROHS, REACH

8. Product care

- Remove dirt carefully with water or a soft wipe.
- Do not rub the surface of the display if it is dirty (e.g. due to mud).
- Do not submerge the product into water.
- Do not clean the product with a high-pressure jet.
- Avoid the contact with oils and greases.
- Do not use hot water in case the buttons are iced.

8.1 Transport and storage

- Protect the product from direct extensive solar radiation.
- Protect the product from extreme temperatures (see temperature specifications).
- Store the product dry and at room temperature during longer non-use.

9. Disposal

The EOX® VIEW 1300 should be disposed of in an environmentally correct manner.

Do not dispose the EOX® VIEW 1300 into house-hold waste.



Only for EC countries

According to the European Guideline 2012/19/EU on waste electrical and electronic equipment as well as the European Guideline 2006/66/EC on batteries and accumulators, devices and batteries must be collected separately and disposed of in an environmentally correct manner.

CE Declaration of Conformity

We, SIGMA-ELEKTRO GmbH, declare that the equipment above has been tested in our facility and found compliance with the requirement limits of applicable standards, in accordance with the RED Directive 2014/53/EU and the ROHS Directive 2011/65/EU and additional according to Directive (EU) 2015/883 to amend Annex II of the above mention Directive with 4 additional substances. The test record, data evaluation and Equipment Under Test (EUT) configurations represented herein are true and accurate under the standards herein specified.

You can find the CE declaration at: ce.sigmasport.com/eoxview1300



Federal Communication Commission Interference Statement

FCC: M5LV1300

Caution: If any changes or modifications not expressly approved by the party responsible for compliance could void the user's authority to operate the equipment.

This device complies with Part 15 of the FCC Rules.

Operation is subject to the following two conditions:

- (1) This device may not cause harmful interference, and
- (2) This device must accept any interference received, including interference that may cause undesired operation.

The grantee is not responsible for any changes or modifications not expressly approved by the party responsible for compliance. Such modifications could void the user's authority to operate the equipment.

The RF Exposure Compliance distance is 5 millimeters.

NOTE: This equipment has been tested and found to comply with the limits for a Class B digital device, pursuant to part 15 of the FCC Rules. These limits are designed to provide reasonable protection against harmful interference in a residential installation. This equipment generates, uses and can radiate radio frequency energy and, if not installed and used in accordance with the instructions, may cause harmful interference to radio communications. However, there is no guarantee that interference will not occur in a particular installation. If this equipment does cause harmful interference to radio or television reception, which can be determined by turning the equipment off and on, the user is encouraged to try to correct the interference by one or more of the following measures:

- Reorient or relocate the receiving antenna.
- Increase the separation between the equipment and receiver.
- Connect the equipment into an outlet on a circuit different from that to which the receiver is connected.
- Consult the dealer or an experienced radio/TV technician for help.

Industry Canada Statement

IC number: 7580A-R500

This device complies with Innovation, Science and Economic Development Canada licence-exempt RSS standard(s).

Operation is subject to the following two conditions:

- (1) this device may not cause interference, and
- (2) this device must accept any interference, including interference that may cause undesired operation of the device.

CAN ICES-3(B)/NMB-3(B)

Le présent appareil est conforme aux CNR Innovation, Sciences et Développement économique Canada applicables aux appareils radio exempts de licence.

L'exploitation est autorisée aux deux conditions suivantes:

- (1) il ne doit pas produire de brouillage et
- (2) l'utilisateur du dispositif doit être prêt à accepter tout brouillage radioélectrique reçu, même si ce brouillage est susceptible de compromettre le fonctionnement du dispositif.

CAN ICES-3(B)/NMB-3(B)

The device meets the exemption from the routine evaluation limits in section 2.5 of RSS 102 and compliance with RSS-102 RF exposure, users can obtain Canadian information on RF exposure and compliance.

Le dispositif rencontre l'exemption des limites courantes d'évaluation dans la section 2.5 de RSS 102 et la conformité à l'exposition de RSS-102 rf, utilisateurs peut obtenir l'information canadienne sur l'exposition et la conformité de rf.

This transmitter must not be co-located or operating in conjunction with any other antenna or transmitter. This equipment should be installed and operated with a minimum distance of 5 millimeters between the radiator and your body.

Cet émetteur ne doit pas être Co-placé ou ne fonctionnant en même temps qu'aucune autre antenne ou émetteur. Cet équipement devrait être installé et actionné avec une distance minimum de 5 millimètres entre le radiateur et votre corps.



SIGMA-ELEKTRO GmbH

Dr.-Julius-Leber-Straße 15
D-67433 Neustadt/Weinstraße
Tel. + 49 (0) 63 21-9120-0
Fax + 49 (0) 63 21-9120-34
E-Mail: info@sigmasport.com